



**A Watch You Can Trust**

**INSTRUCTION MANUAL FOR  
WATCH CALIBRE  
Z015**



**WARNING**



**THIS PRODUCT CONTAINS A BUTTON BATTERY**

If swallowed or placed inside any part of the body, the battery can cause severe or fatal injuries within 2 hours or less.

Button batteries are hazardous whether new or used. Keep batteries out of reach of children.

If you think the battery may have been swallowed or placed inside any part of the body, seek immediate medical attention. Contact the Australian

Poisons Information Centre immediately on 13 11 26

(New Zealand 0800 764 766) for 24 / 7 fast, expert advice.

### ■ CHARACTERISTICS

- 1. Time mode**  
Display of hour, minute, second, month, date and Day of the week. Choice between 12-hour format and 24-hour format. Dual time display function. Hourly chime signal.
- 2. Heart rate measurement mode (HRM mode)**  
Heart rate measurement with finger sensor. The watch can measure your heart rate and percentage of maximum heart rate (MHR.)  
**Heart Rate Training Zone Alert**  
If the tested heart rate exceeds the limit settings, the watch will beep and display will flash to give you audio and visual alert. It will remind you to adjust exercise intensity to stay in target heart rate zone.
- 3. Stopwatch mode**  
Measurement of up to 23 hours 59 minutes and 59 seconds in 1/100-second increments. Lap time measurement is possible.
- 4. Recall mode**  
A maximum of 16 exercise data can be recorded, including exercise time, heart rate and percentage of maximum heart rate (MHR.)
- 5. Calorie mode**  
Display of calories consumed, fat burnt and BMI (Body Mass Index) based on pre-filled personal data
- 6. Alarm mode**  
4-channel alarm including "ONCE (single-time alarm)" "Monday to Friday", "Monday to Saturday" and "ALL (daily alarm)"
- 7. Timer mode**  
Measurement of up to 23 hours 59 minutes and 59 seconds
- 8. Illuminating Light**  
If you press Button D, the built-in electro-luminescent (EL) light illuminates the display for easy viewing in darkness.

### ■ BUTTONS AND DISPLAYS

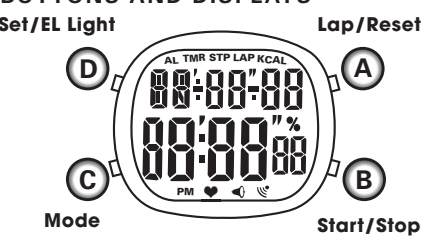

To change the display mode, press Button C. The display mode changes in the following order.

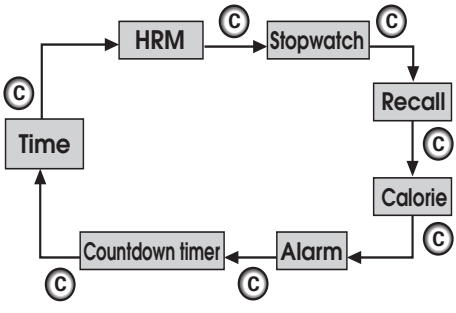

### ■ TIME MODE

#### Dual Time Display function

The watch can display the time in two time zones: local time zone and second time zone. To switch between the time zones, press Button A.

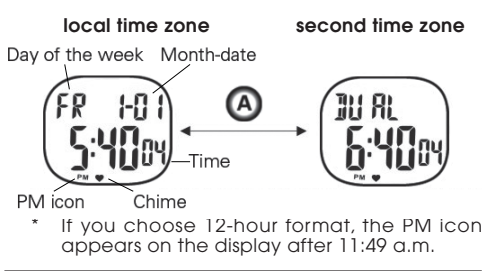

#### How to set the hourly chime

Press Button B to turn the hourly chime ON or OFF. When the hourly time is turned on, the chime icon appears on the display.

#### How to set the time/calendar

- In the Time mode, keep pressing down Button D for 2 seconds to enter the time setting mode. (The second digits start flashing.)
- <Second setting>**

Press Button A or B in accordance with a time signal. The second digits are reset to "00" and start counting immediately. When the second digits are greater than "29," one minute is added and the second digits are reset to "00."

- Press Button C to confirm the second setting and move on to the next item. Selection of the item to be adjusted (flashing) is made in the following order when Button C is pressed.

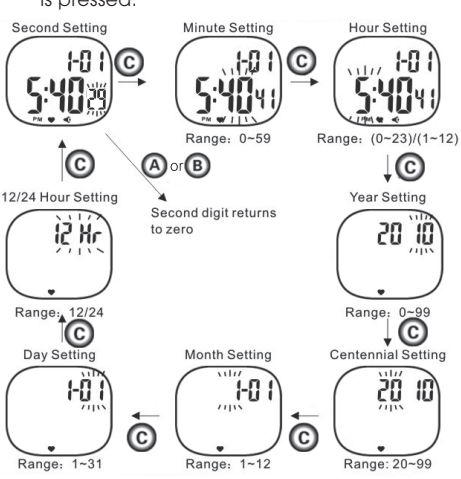

- To set the digits for each item, press Button A to increase the digits or press Button B to decrease the digits. Keep pressing down each button to fast-forward or fast-backward.
- After all the adjustments are completed, press Button D to return to the Time mode.

#### How to set the time in the second time zone

- In the Time mode, press Button A to display the second time zone.
- Keep pressing down Button D for 2 seconds to enter the time setting mode.
- Press Button C to switch the items to be adjusted.
- To set the digits for each item, press Button A to increase the digits or press Button B to decrease the digits. Keep pressing down each button to fast-forward or fast-backward. During the minute setting, the minute digits increase or decrease by 30 at a time.
- After all the adjustments are completed, press Button D to exit the time setting mode.

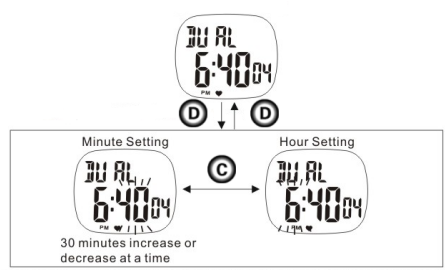

### ■ HEART RATE MEASUREMENT MODE

Press Button C until the watch enters the Heart rate measurement (HRM) mode.

After the watch enters the HRM mode, the measurement circuit is automatically activated. If no heart rate signal is detected, or the heart rate signal is inconsistent, the heart rate measurement function will be automatically inactivated to save power. If this happens, press Button A to reactivate the heart rate measurement function.

#### How to measure your heart rate

- Wear the watch on your wrist.
- Lay your fingers down flat, firmly on the two sensor areas as shown in the pictures below.



- When your heart rate is displayed, press Button B to save it.

#### Tips for accurate heart rate reading

- Press your fingers with equal strength and stay motionless.
- If your fingers are extremely dry, moisten your fingers.
- If the temperature is low, rub your hands to warm them up.

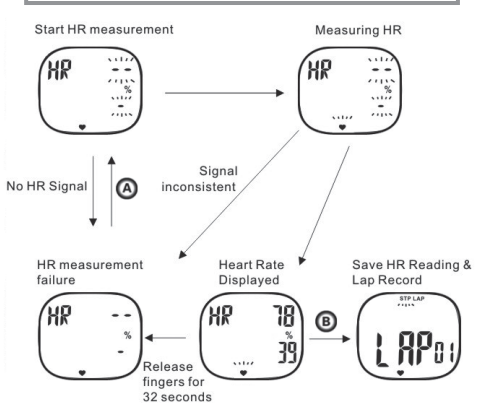

#### Exercise Mode

Please input your personal information before doing exercise and measuring heart rate. When you start exercising, turn the stopwatch ON, and then enter the HRM mode. The result of heart rate measurement will be used to calculate calorie consumption and fat burnt. After your heart rate reading is obtained, press Button B to save the current lap record and heart rate reading. The watch can record 15 groups of data at the most. The calculation of calorie consumption and fat burnt won't be influenced even if you don't save the data. Stop the stopwatch if you don't want to get your heart rate measured.

### ■ STOPWATCH MODE

- Press Button C until the watch enters the Stopwatch mode.
- Press Button A to start or stop the stopwatch.
- Press Button B to record lap times. Up to 16 lap time records can be saved.



- To delete an exercise record, which includes lap time, heart rate, calorie consumed and fat burnt, keep pressing down Button B for 2 seconds.
- If you change the mode to a different mode while the stopwatch is running, the stopwatch keeps running with the "STP" indicator flashing on the display.

### ■ RECALL MODE

If the stopwatch is running, skip the Recall mode when you press Button C to switch modes.

- Press Button C until the watch enters the Recall mode.
- Press Button A to display the recorded data one by one.
- To delete all the records including lap time, heart rate, calorie consumed and fat burnt, keep pressing down Button B for 2 seconds.

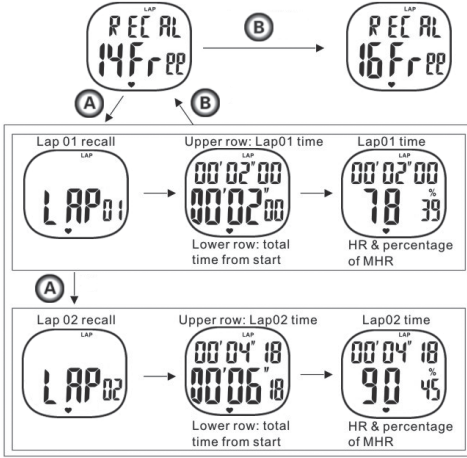

### ■ CALORIE MODE

- Press Button C until the watch enters the Calorie mode.
- Press Button A to switch between calorie consumption display (kcal) and fat burnt display (kg and lbs.)
- Keep pressing down Button B to display BMI.

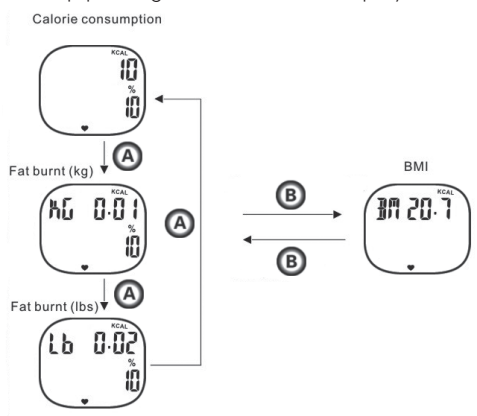

- Calculations in the Calorie mode is based on the data obtained by the stopwatch and heart rate measurement.
- For accurate calculation of calorie consumption and fat burnt, start the stopwatch first and keep measuring your heart rate.

### ■ PERSONAL INFORMATION SETTING

Set up your personal data before you measure your heart rate or do exercise. Based on your personal data, the watch calculates calorie consumed and fat burned while you exercising.

#### How to input your personal information

- In the Calorie mode, keep pressing Button D for 2 seconds, to enter the personal data setting mode.
- Press Button C to switch the item to be adjusted. Selection of the item to be adjusted (flashing) is made in the following order when Button C is pressed.

F/M => AGE => KG => HG => TG => EM => HI => LO

- To set the digits for each item, press Button A to increase the digits or press Button B to decrease the digits. Keep pressing down each button to fast-forward or fast-backward. To set the gender, press either Button A or Button B to switch between F (female) and M (male.)
- Press Button D to exit the personal data setting mode.

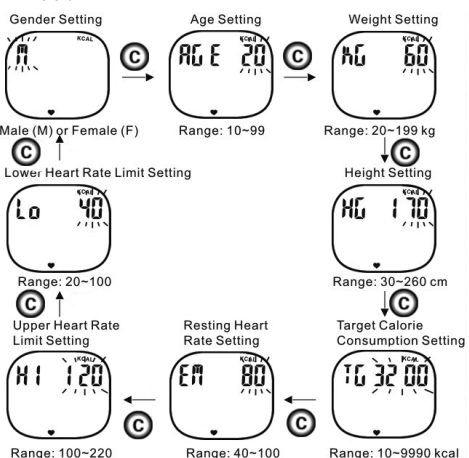

When setting weight, the unit of weight is the same as that of fat burnt. If the unit for fat burnt is KG, then the unit for weight is also KG. If the unit for fat burnt is LBS, then the unit for weight is also LBS. Default unit is KG.

If the tested heart rate exceeds the limit settings, the watch will beep and display will flash to give you audio and visual alert. You can adjust exercise intensity accordingly to optimize the workout effect.

**When the stopwatch is running, you cannot set the personal information.**

### ■ ALARM MODE

- Press Button C until the watch enters the Alarm mode.
- Press Button A to select the alarm channel.

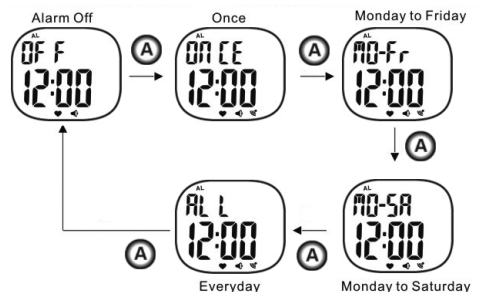

### How to set the alarm

- In the selected alarm channel, keep holding down Button D for 2 seconds to enter the alarm setting mode.
- Press Button C to switch the items to be adjusted.

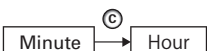

- To set the digits for each item, press Button A to increase the digits or press Button B to decrease the digits. Keep pressing down each button to fast-forward or fast-backward.
- After all the alarm settings are completed, press Button D to exit the alarm setting mode.

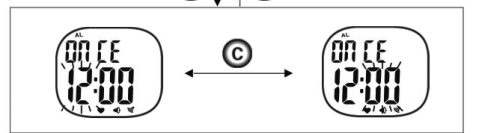

- \* The alarm sounds at the designated time for 20 seconds.
- \* To stop the alarm, press any button.

### ■ COUNTDOWN TIMER MODE

Press Button C until the watch enters the Countdown timer mode.

### How to set the countdown period

- Keep pressing down Button D for 2 seconds to enter the timer setting mode.
- Press Button C to switch the items to be adjusted.

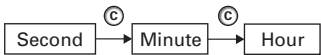

- To set the digits for each item, press Button A to increase the digits or press Button B to decrease the digits. Keep pressing down each button to fast-forward or fast-backward.
- Press Button D to confirm the timer setting and exit the timer setting mode.

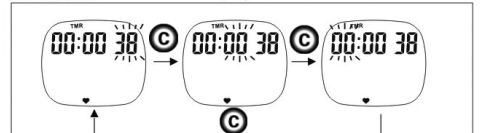

### How to use the countdown timer

Press Button A to start or stop the countdown timer.

When the countdown is stopped, press Button B and the countdown time will automatically restore to the last setting. To stop the alarm, press any button.

- If you change the mode to a different mode while the countdown timer is running, the timer keeps running with the "TMR" indicator flashing on the display.

### ■ APPENDIX

#### Relationship between percentage of MHR and Fat Burnt

Generally, individual heart rate varies person to person. The minimal heart rate for a normal person is resting heart rate, (RHR), which is about a person's heart rate in the morning: awake but still lying down with no physical exertion. The maximal safe heart rate for an individual is maximum heart rate (MHR), which is based on one's age. Percentage of MHR relates to one's MHR.

The higher the percentage of MHR, the more calories consumed. Those calories are from sugar and fat. The relationship between percentage of MHR and calorie consumption is shown in below form.

Percentage of MHR	Exercise intensity	Exercise effect	Fat and sugar burnt
<50%	Rest or moderate exercise (e.g. walking)		Low calorie expenditure and mainly sugar burnt
50% - 60%	Jogging. Breathing is regular.	Warm-up aerobic exercise; stress relief	Fat burnt increases and less sugar burnt
60% - 70%	Running at a comfortable speed. Breathing becomes deeper. You can carry on a conversation.	Cardiovascular exercise; the speed you drop back to after running at a fast speed; weight loss	Maximum fat burnt and less sugar burnt
70% - 80%	Running at a moderate speed. You can only talk in short phrases.	Improve aerobic capacity. The best zone for improving cardiovascular and respiratory systems.	Less fat but more sugar burnt
80% - 90%	Running at a fast speed. Breathing is heavy.	Improve anaerobic capacity; develop speed.	Seldom fat but maximum sugar burnt
90% - 100%	Sprinting. Breathing is labored. Most people can only stay in this zone for short periods.	Improve anaerobic exercise performance and your tolerance; develop muscles.	Maximum sugar burnt and almost no fat burnt

### BMI

The body mass index (BMI) is a statistical measure of body weight based on a person's weight and height. BMI provides a reliable indicator of body fatness for most people, which allows for the comparison of individuals of different heights in terms of their weight. BMI is widely used to identify weight problems within a population, usually whether individuals are normal, overweight or obese.

However, please remember that BMI is only a guide and other issues such as body type and shape have a bearing as well. Therefore, it does not accurately apply to juveniles, athletes, elderly populations, pregnant women or those who are doing weight training. If you think your BMI is incorrect, please consult your doctor and do body fat test.

### BMI for adults (just a guide)

BMI range kg/m <sup>2</sup>	Category
Less than 18	Underweight
18.5 - 24.9	Normal
22 - 24	Fitness
Over 25	Overweight

### ■ ILLUMINATING LIGHT

In any mode press Button D to illuminate the display for about 4 seconds.

**Note:**

- The backlight of the watch employs an electro-luminescent (EL) light, which tends to lose illuminating power after very long use.
- The illumination provided by backlight may be hard to see when viewed under direct sunlight.

### ■ BATTERY CHANGE

The miniature battery CR2032 which powers your watch should last approximately 2 years. However, because it is inserted at the factory, the actual life of the battery once in your possession may be less than 2 years.

Be sure to replace the battery to prevent any possible malfunction as soon as it runs down. To replace the battery we recommend taking the watch to a local watch repair shop.

**Note:** If the alarm and timer are used for more than 20 seconds a day, the illuminating light for more than 3 seconds a day, and the heart rate is tested 15 times a day for 30 seconds, the battery life may be less than the specified period.

### ■ CARE OF YOUR LORUS WATCH

This watch contains precise electronic components. Never attempt to open the case or remove the back cover.

#### • BATTERY

**CAUTION**

**Do not expose the old battery to fire or recharge it. Keep it at a place beyond the reach of children. If a child swallows it, consult a doctor immediately.**

#### • WATER RESISTANT

Condition of use	Accidental contact with water, such as splashes and rain	Swimming and taking a shower	Skin diving	Scuba diving
Indication on the dial/case back				
<b>No Indication</b>	NO	NO	NO	NO
<b>WATER RESISTANT</b>	YES	NO	NO	NO
<b>WATER RESISTANT (50M/5 BAR)</b>	YES	YES	NO	NO
<b>WATER RESISTANT (100M/10 BAR or above)</b>	YES	YES	YES	NO

\* If your watch is 200 M/20 BAR, 100 M/10 BAR or 50 M/5 BAR water resistant, it is so indicated on the dial/case back.

- Do not operate the buttons when the watch is wet.
- If the watch is exposed to salt water, rinse it in fresh water and then wipe it thoroughly dry.
- Should you find any water or condensation inside the watch, immediately have it checked. Water can corrode electronic parts inside the case.

#### Caution:

Leather straps are not water resistant except so indicated, even if the watch head is water resistant.

#### • ALLERGIC REACTION

Because the case and band touch the skin directly, it is important to clean them regularly. If not, shirt sleeves may be stained and those with delicate skin may develop a rash. Please wear the watch with some play to avoid any possible allergic reaction. If you develop a rash on your wrist, stop wearing and consult a physician.

#### • MAGNETISM

Your watch will be adversely affected by strong magnetism. Keep it away from close contact with magnetic objects.

#### • SHOCKS AND VIBRATIONS

Your watch may be worn for normal sports activities, but be careful not to drop it or hit it on hard surfaces.

#### • TEMPERATURE

Your watch is preadjusted so that constant accuracy may be insured at normal temperature.

#### • CLEANING

Use only a soft cloth and clean water for cleaning your watch. Never use chemicals, as the waterproof gasket will corrode.

### ■ SERVICE

When your LORUS watch requires REPAIR or servicing, please see the enclosed WARRANTY/GUARANTEE.